

FOTO 01



FOTO 02



FOTO 03



FOTO 04



FOTO 05

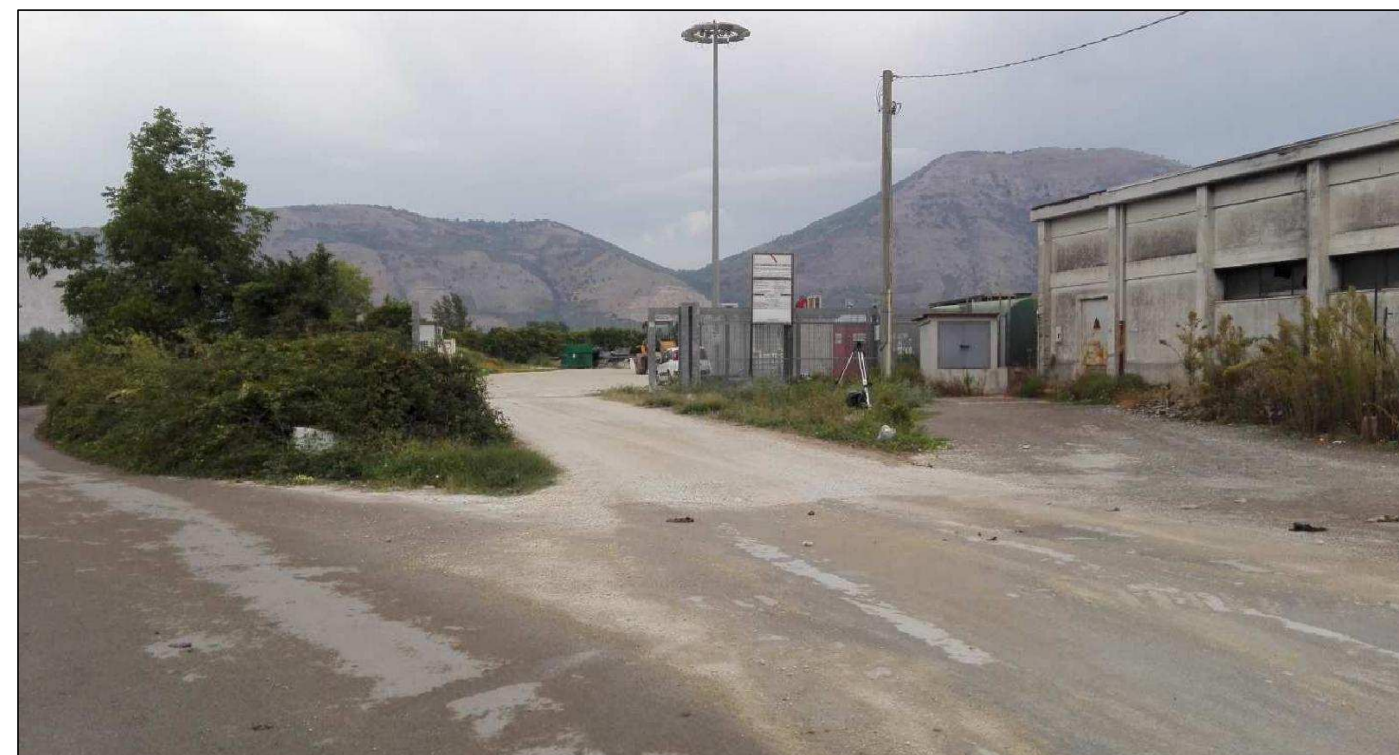

FOTO 06



FOTO 07

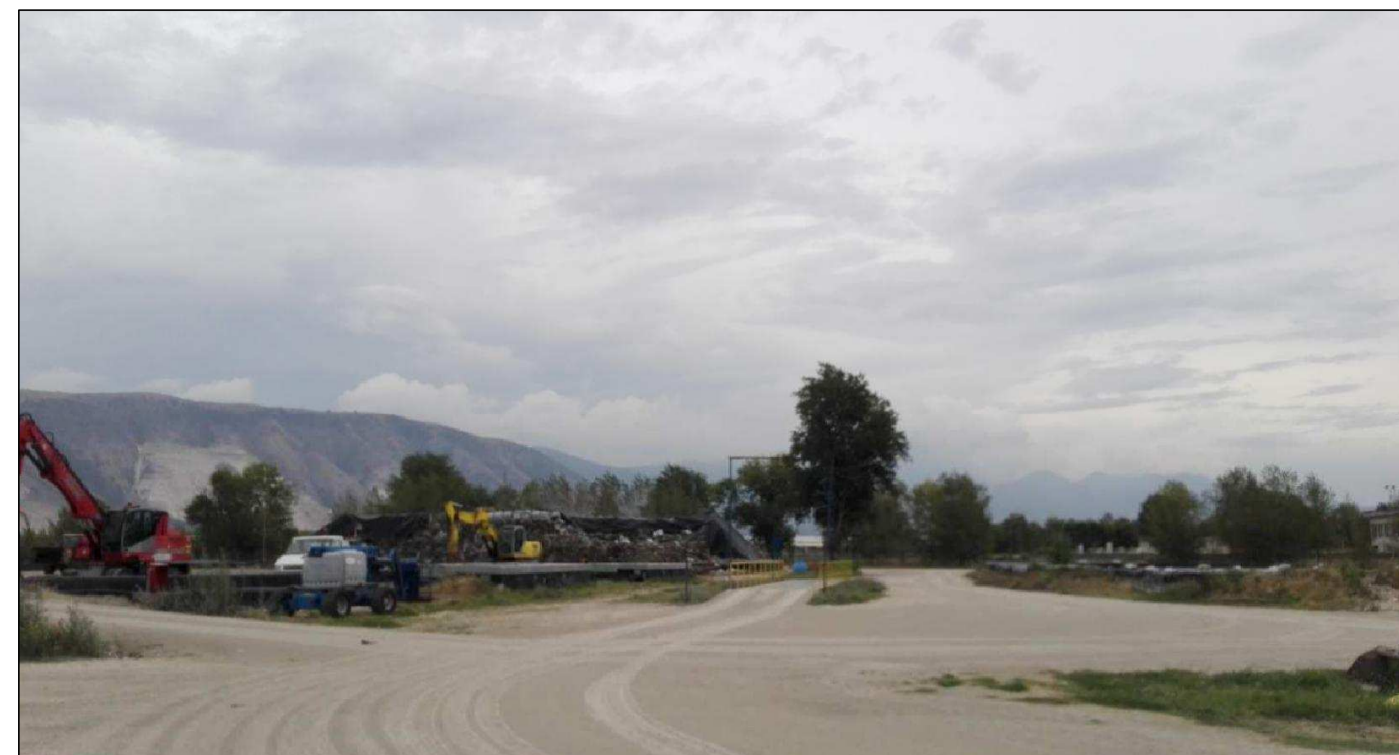

FOTO 08



FOTO 09

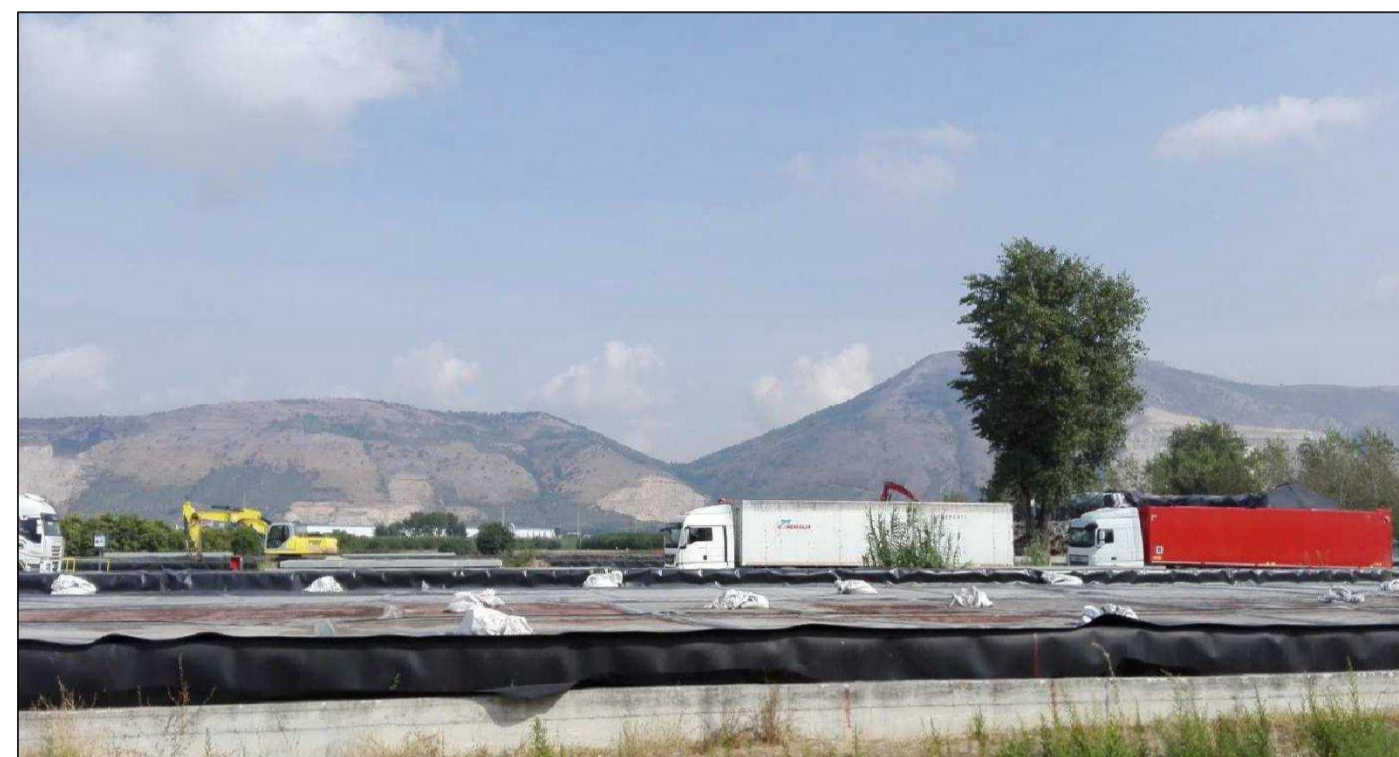

FOTO 10



FOTO 11



FOTO 12



FOTO 13



FOTO 14



FOTO 15

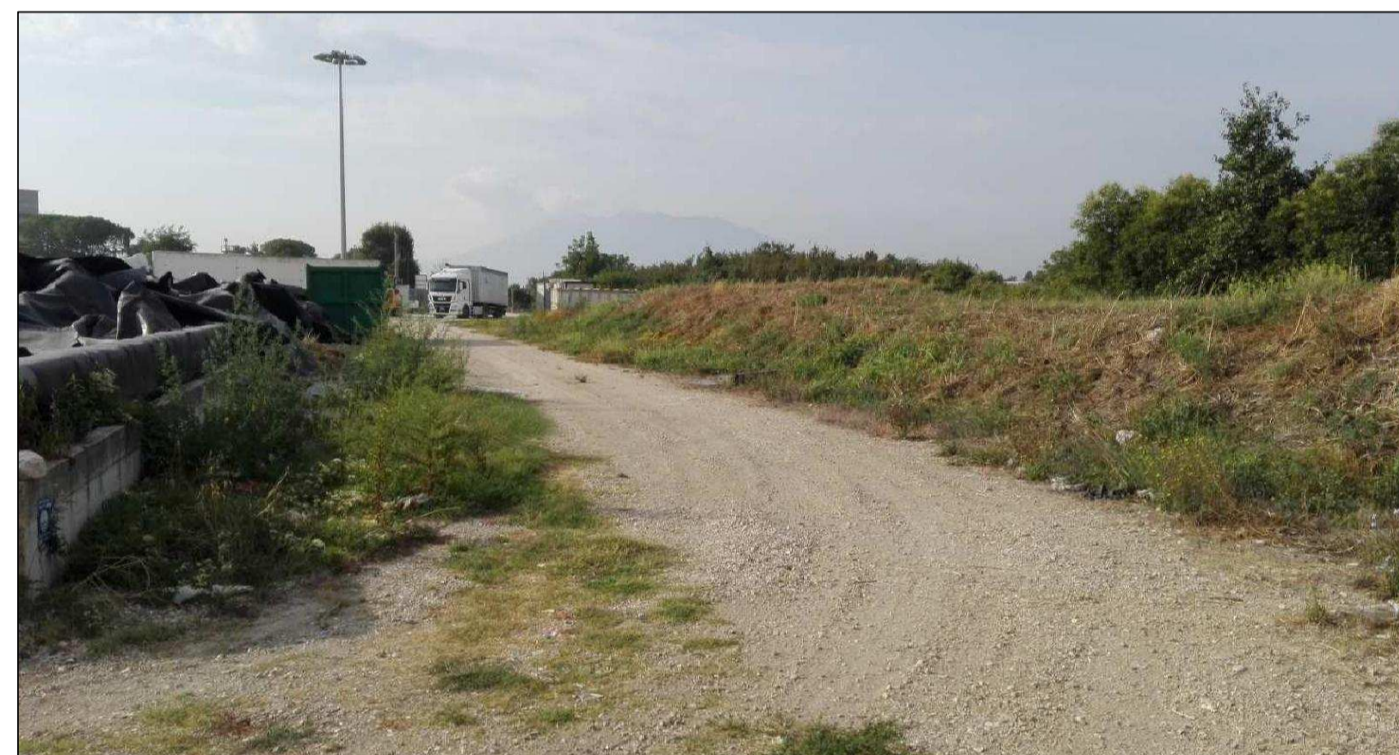

FOTO 16



FOTO 17



FOTO 18



FOTO 19



FOTO 20

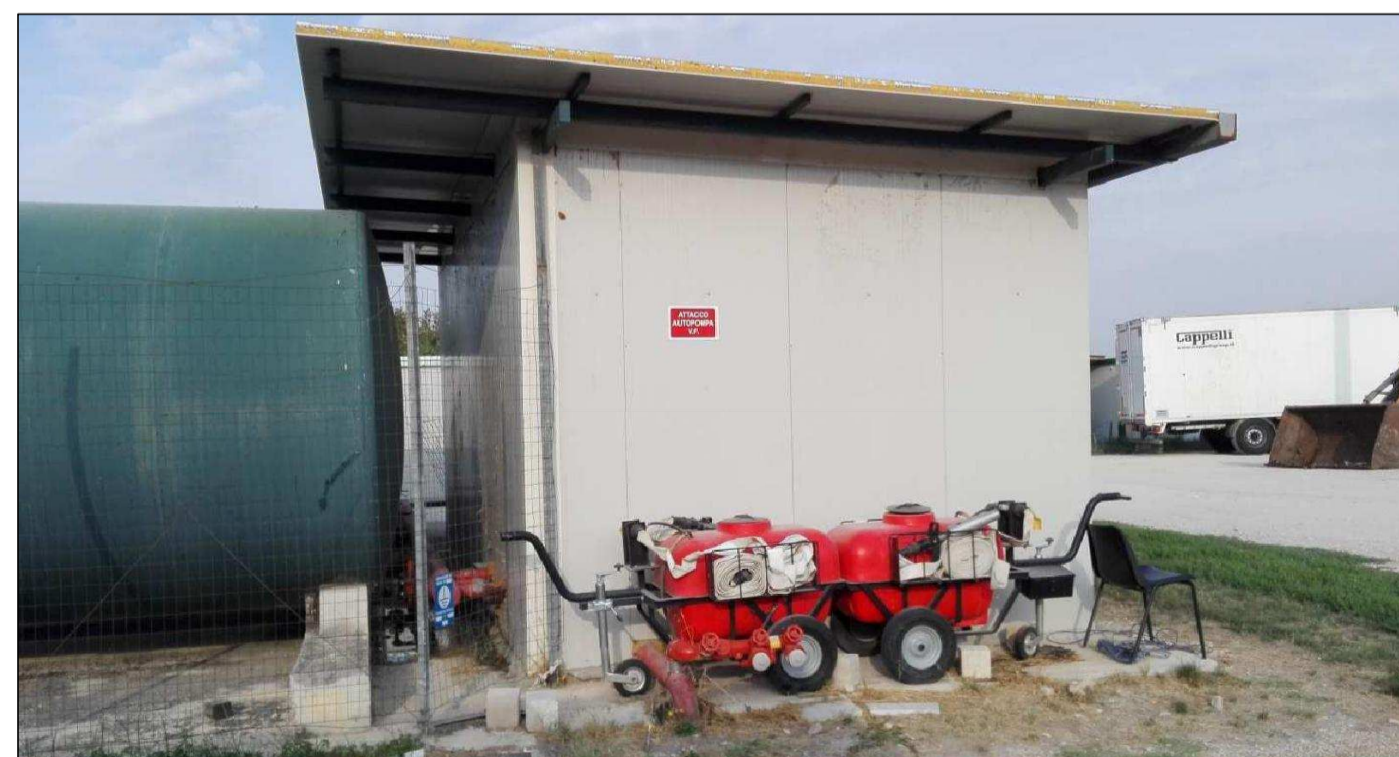

FOTO 21



FOTO 22



FOTO 23



FOTO 24

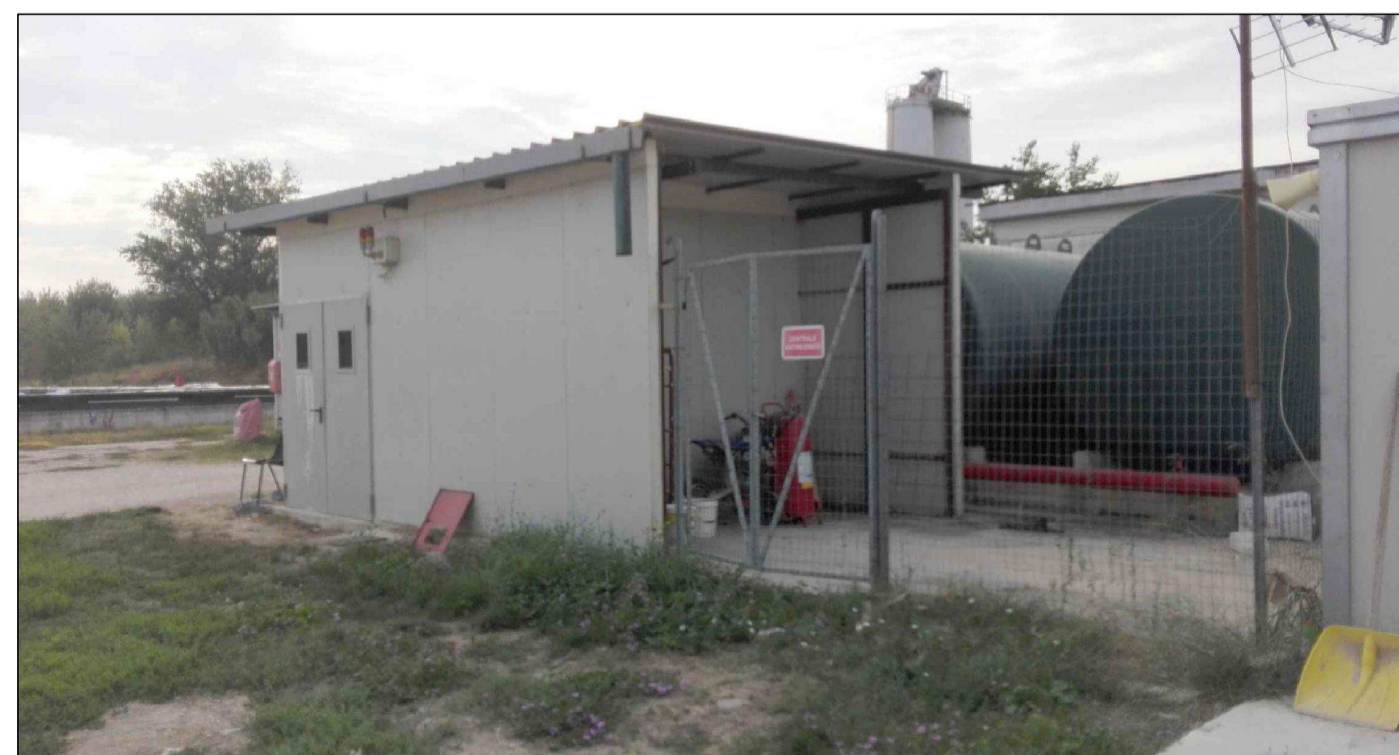

FOTO 25



PIANTA CHIAVE:

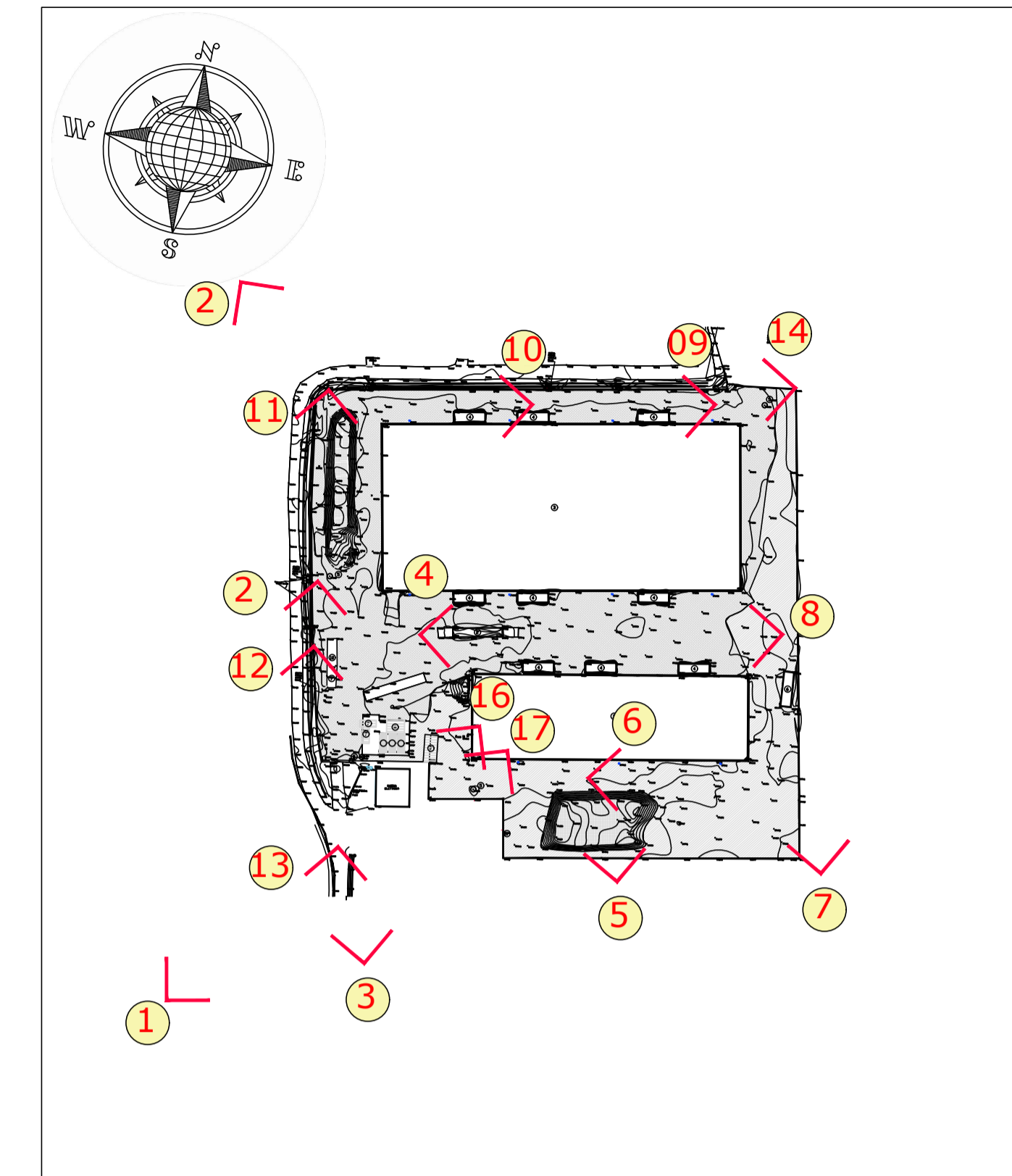

REGIONE CAMPANIA GIUNTA REGIONALE DELLA CAMPANIA

PROGETTAZIONE E REALIZZAZIONE DEI LAVORI RELATIVI ALLA COSTRUZIONE DI UN IMPIANTO PER IL TRATTAMENTO DELLA FRAZIONE ORGANICA PROVENIENTE DALLA RACCOLTA DIFFERENZIATA DEI RSU NEL COMUNE DI MARIGLIANO (NA). PROCEDURA N. 3487/AP/2022 - CUP: B96G17000900001 - CIG: 935815951B PROGETTO DEFINITIVO



IMPRESA CAPOGRUPPO: INFRA TECH Consorzio Stabile S.C. a R.L. con sede legale in MILANO P.zza Quattro Novembre n. 7 Tel: 0815621498 gare@pec.infrotech.it

SUB RAGGRUPPAMENTO DI PROGETTISTI: C.G.A. S.r.l., CUBE S.r.l., DRISALDI ASSOCIATI, Prof. Ing. GIOVANNI PERILLO, Dott. Geol. PASQUALE MANARA

ELABORATO: STATO DI FATTO Documentazione fotografica

Table with columns for revision history (prog., tipo elab., argomento, progress., revisione, data, scala, plot) and a table for document revisions (rev, data, descrizione, redatto, approvato).